

PXM(e)7820 High Speed Multi-Measurement Device



TECHNICAL DATA SHEET

PXI

Features

VXI

LAN

cPCI

PXIe

GPIB

USB

RS232
485

external
PCIe

- High voltage range with up to 500 V_{pp}
- 16 Bit Waveform Digitizer 64 MS, 10 MS/s
- High precision Digital Multimeter with 16 Bit resolution
- Fully isolated design
- >1 GΩ || <20 pF input impedance up to 8V range
- 10 MΩ || <20 pF for all other ranges
- Extremely low switching time of <1 ms for ranges and functions
- 2- and 4-wire resistance measurement
- Highly configurable trigger matrix
- Trigger engine for instrument synchronization
- Built-in timer/counter engine
- Electronic protection against overcurrent and overvoltage
- Memory segmenting
- Available with PXI or PXIExpress interface

Product Information

General

The PXM(e)7820 High Speed Multi-Measurement Device combines a 16 Bit DMM, a 10 MS/s Digitizer with a resolution of 16 Bit, a timer/counter and a trigger card. One special feature of the PXM(e)7820 is a very high input impedance of $10\text{ M}\Omega \parallel <20\text{ pF}$ also in all AC ranges. Therefore the influence on DC and AC signals is reduced to a minimum. A trigger input and output is provided as well as electronic protection against overvoltage and overcurrent.

High voltage, high resolution Waveform Digitizer

The PXM(e)7820 High Speed Multi-Measurement Device features waveform sampling with 10 MS/s, 16 Bit resolution, input voltages up to $\pm 250\text{ V}_p$ and a bandwidth up to 5 MHz. This allows the measurement of high voltage signals without additional signal conditioning. Data can be acquired before and after the trigger event with a programmable sample counter that controls a number of up to 64 million data points. The memory segmenting function allows to save different digitizing events in the memory. A great amount of trigger capabilities results in multiple instrument and channel synchronization possibilities.

High precision Digital Multimeter

The PXM(e)7820 High Speed Multi-Measurement Device features a high precision Digital Multimeter (DMM) for high performance measurements with 16 Bit resolution. It provides measurement of DC voltage up to 250 V, AC voltage up to 250 V_p , DC current up to 1 A and AC current up to 2 A_p .

High resolution timer/counter

The PXM(e)7820 High Speed Multi-Measurement Device features a high precision timer/counter for high performance measurements of frequency, period time, interval and pulse width and rise and fall times with a resolution of up to 100 ns.

Configurable trigger matrix

The PXM(e)7820 High Speed Multi-Measurement Device features a complex trigger matrix. Both trigger connectors, internal trigger events and all trigger lines on the backplane can be connected individually.

High throughput design for many applications

The PXM(e)7820 High Speed Multi-Measurement Device is designed for high throughput production testing. One key feature is the extremely low switching time of $<1\text{ ms}$ for the changing of ranges and functions like switching from AC to DC.

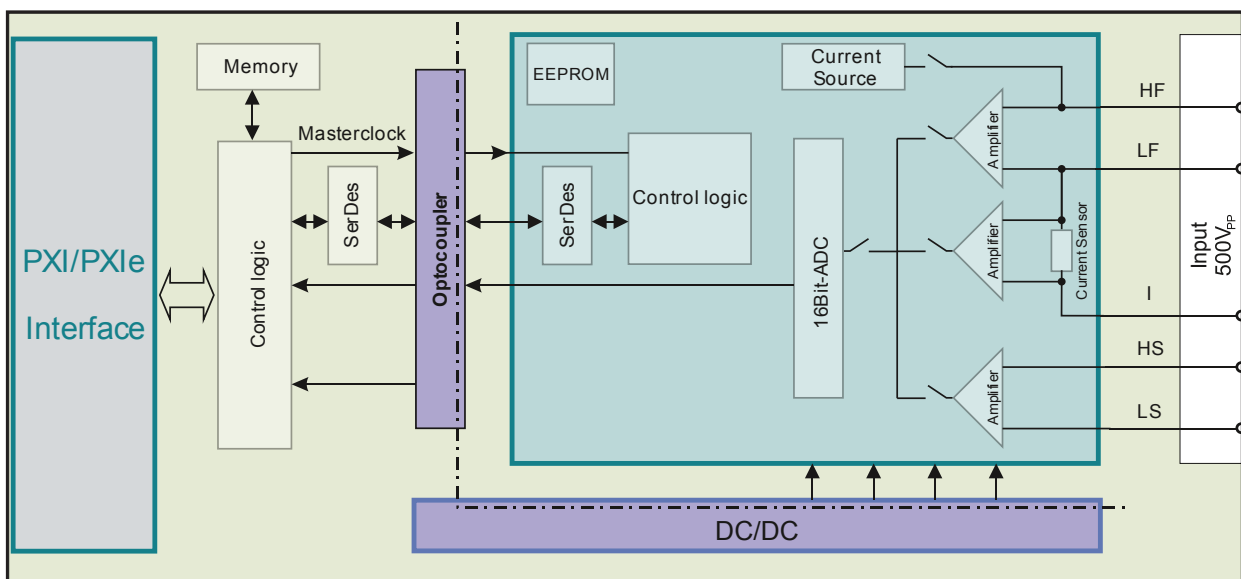

General	Specification	Comment
Module size	1 slot, 3U	
Module weight	<0.7 kg	
Front connector type	FM5W5P	
Storage temperature range	-25... 70°C	
Operating temperature	0... 40°C	
Operating altitude	<2000 m	
Relative humidity	Up to 85% at 35°C	
Electrical safety	According EN61010-1	
Isolation input to PE	250 V CAT I, Pollution Degree 2	

Waveform Digitizer

Acquisition	Specification	Comment
Maximum sample rate	10 MS/s	
Bandwidth		
Range 250 mV _p , 500 mV _p	>2 MHz	0.5 V _{pp} input signal; no filter
Range 1 V _p , 2 V _p , 4 V _p , 8 V _p	>5 MHz	2 V _{pp} input signal; no filter
All other ranges	>1 MHz	20 V _{pp} input signal; no filter
Vertical resolution	16 Bit	
Sampling interval	100 ns... 1 s	Software selectable
Input impedance	10 MΩ // <20 pF	
Input coupling	DC or AC	Software selectable
Maximum input voltage	f < 40 kHz: 250 V _p 40 kHz < f < 1 MHz: 10 ⁷ V _p / f 1 MHz < f < 5 MHz: 10 V _p	Input voltage may not exceed selected input voltage range
Input ranges	250 mV _p , 500 mV _p , 1 V _p , 2 V _p , 4 V _p , 8 V _p , 16 V _p , 32 V _p , 64 V _p , 128 V _p , 250 V _p	5% overrange 5% overrange
DC accuracy¹		
Range 250 mV _p	0.2 + 0.2	±(% of input + % of full scale)
Range 500 mV _p	0.15 + 0.15	±(% of input + % of full scale)
All other ranges	0.1 + 0.1	±(% of input + % of full scale)
Filter	1 kHz, 10 kHz, 100 kHz, 1 MHz	Software selectable
Waveform memory	64 MS	

Time Base	Specification	Comment
Accuracy	1 ppm	In operating temperature range
Aging per year	1 ppm	In operating temperature range

¹ DC accuracy specified for an average value of 100 samples with a sample rate of 5 kS/s and active 10 kHz filter performed within 24 hours after an offset correction.

Notes: All product data are specified for 1 year at an ambient temperature of 23°C ±5°C (after 1 hour warm-up time). Product specification and description in this document are subject to change without notice.

Trigger

Trigger System	Specification	Comment
Input from		
Internal function module	Module can trigger itself	
Software	Via software command	
Front connector	Front trigger input (TTL level)	
PXI trigger	Trigger 0...7 and star trigger	From the PXI backplane
Output to		
Internal function module	Module can trigger itself	
Front connector	Front trigger output (TTL level)	
PXI trigger	Trigger 0...7	To the PXI backplane
Level resolution	16 Bit	
Level accuracy	0.6 + 0.3	±(% of programmed value + % of full range)
Trigger delay	0...200 s	Programmable delay, 100 ns resolution
Trigger slope	Positive or negative	
Trigger hysteresis	0... 100% of signal range	Programmable via software
Pre-Trigger	0... 100% of full record length	Trigger is armed after all pre-samples are captured; post-samples are captured after trigger
Post-Trigger	0... 100% of full record length	Number of samples captured after trigger event
Trigger Mode	Asynchronous, synchronous level, synchronous slope	

Timer/Counter

T/C Measurement Modes	Specification
Frequency	
Counter width	32 Bit
Range	0.1 Hz... 2.5 MHz
Minimum pulse width	200 ns
Gate time	1 μs... 10 s
Period	
Resolution	100 ns
Accuracy ^{1,2}	±100 ns
Range	1 μs... 10 s
Time interval and pulse width	
Resolution	100 ns
Accuracy ²	±100 ns
Range	1 μs... 10 s
Rise and fall time	
Resolution	100 ns
Accuracy ²	±100 ns
Range	1 μs... 10 s
Totalize	
Minimum pulse width	1 μs
Range	0... 2 ³² -1

¹ Square wave signal with $T_{\text{Rise}} < 1 \text{ ns}$ and $T_{\text{Fall}} < 1 \text{ ns}$.

² Trigger comparator error not included.

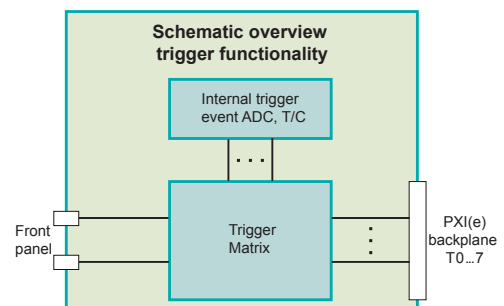

Digital Multimeter (DMM)

DC Voltage Measurement	Specification	Comment
Resolution	16 Bit	
Maximum input voltage	±250 V	
Overrange	5% of range	
Filter frequencies	100 Hz, 1 kHz, 10 kHz, 100 kHz	Software selectable
DC accuracy^{1,2,5,7}		
Range 250 mV	0.08 + 0.02	Input resistance >1 GΩ
Range 500 mV	0.08 + 0.015	Input resistance >1 GΩ
Range 1 V	0.08 + 0.01	Input resistance >1 GΩ
Range 2 V	0.08 + 0.01	Input resistance >1 GΩ
Range 4 V	0.08 + 0.01	Input resistance >1 GΩ
Range 8 V	0.08 + 0.01	Input resistance >1 GΩ
Range 16 V	0.08 + 0.01	Input resistance 10 MΩ
Range 32 V	0.08 + 0.01	Input resistance 10 MΩ
Range 64 V	0.08 + 0.01	Input resistance 10 MΩ
Range 128 V	0.08 + 0.01	Input resistance 10 MΩ
Range 250 V	0.08 + 0.01	Input resistance 10 MΩ

AC Voltage Measurement	Specification	Comment
Resolution	16 Bit	
Input impedance	10 MΩ // <20 pF	
Maximum input voltage	f < 40 kHz: 250 V _p 40 kHz < f < 1 MHz: 10 ⁷ V _p / f 1 MHz < f < 5 MHz: 10 V _p	Input voltage may not exceed selected input voltage range
Overrange	5% of range	

AC Voltage Accuracy ^{1,2,3,4,5,8}	1 ... 40 Hz ⁶	40 Hz ... 20 kHz	20 ... 50 kHz	50 ... 100 kHz
Range 250 mV_{RMS}	0.4 + 0.1	0.4 + 0.1	0.3 + 0.15	0.8 + 0.1
Range 500 mV_{RMS}	0.3 + 0.1	0.2 + 0.1	0.2 + 0.1	0.8 + 0.1
Range 1 V_{RMS}	0.15 + 0.1	0.15 + 0.1	0.2 + 0.1	0.8 + 0.1
Range 2 V_{RMS}	0.15 + 0.1	0.1 + 0.1	0.2 + 0.1	0.8 + 0.1
Range 4 V_{RMS}	0.15 + 0.1	0.1 + 0.1	0.2 + 0.1	0.8 + 0.1
Range 8 V_{RMS}	0.15 + 0.1	0.1 + 0.1	0.2 + 0.1	0.8 + 0.1
Range 16 V_{RMS}	0.15 + 0.1	0.1 + 0.1	0.2 + 0.1	0.8 + 0.1
Range 32 V_{RMS}	0.15 + 0.1	0.1 + 0.1	0.2 + 0.1	0.8 + 0.1
Range 64 V_{RMS}	0.15 + 0.1	0.1 + 0.1	0.2 + 0.1	0.8 + 0.1
Range 128 V_{RMS}	0.15 + 0.1	0.1 + 0.1	0.2 + 0.1	0.8 + 0.1 ⁹

¹ For measurements >10% of range.
² ±(% of reading + % of full scale).
³ For sine wave signals >5% of range.
⁴ Maximum peak input voltage = 2x full scale (e.g. maximum input voltage for 128 V_{RMS} range = ±256 V_p).
⁵ With auto offset correction.
⁶ With DC coupling.
⁷ 5 PLC.
⁸ Measurement aperture greater than 5/f_{Low}, where f_{Low} is the lowest frequency component of the signal being measured.
⁹ Maximum input voltage must be satisfied.

DC Current Measurement	Specification	Comment
Resolution	16 Bit	
Maximum input current	± 1 A	
Overrange	5% of range	
Filter frequencies	100 Hz, 1 kHz, 10 kHz, 100 kHz	Software selectable
DC accuracy ^{1,3,4}		
Range 10 mA	0.2 + 0.05	
Range 100 mA	0.2 + 0.05	
Range 1 A	0.2 + 0.05	

AC Current Measurement	Specification	Comment
Resolution	16 Bit	
Maximum input current	$\pm 2 A_p$	
Overrange	5% of range	

AC Current Accuracy ^{2,3,4,5,6}	40 Hz ... 5 kHz	5 kHz ... 20 kHz
Range 10 mA_{RMS}	0.3 + 0.1	0.5 + 0.3
Range 100 mA_{RMS}	0.1 + 0.02	0.2 + 0.04
Range 1 A_{RMS}	0.1 + 0.02	0.3 + 0.04

¹ For measurements >8% of range.

² For sine wave signals >8% of range.

³ With auto offset correction.

⁴ \pm (% of reading + % of full scale).

⁵ Maximum peak input current = 2x full scale (e.g. maximum input current for 1 A_{RMS} range = $\pm 2 A_p$).

⁶ With DC coupling.

Resistance

Resistance Measurement	Specification	Comment
Resolution	16 Bit	
Overrange	5% of range	
Resistance accuracy ^{1,2,3,4}		
Range 100Ω	0.1 + 0.01	Test current 8 mA
Range 1 kΩ	0.1 + 0.01	Test current 8 mA
Range 10 kΩ	0.1 + 0.01	Test current 800 μA
Range 100 kΩ	0.1 + 0.01	Test current 80 μA
Range 1 MΩ	0.1 + 0.01	Test current 8 μA
Range 10 MΩ	0.1 + 0.01	Test current 800 nA

PXI(e) Trigger

PXI Capabilities	Specification	Comment
PXI(e) TTL/trigger usage	Possible	PXI(e) trigger 0...7; input and output
PXI(e) star trigger usage	Possible	Input only

Operating Times

Scope of Application	Specification	Comment
Ranges	<1 ms	
Functions ⁵	<1 ms	For all U-, I-, R-Ranges ⁵

- ¹ For measurements >8% of range.
- ² Only 4 wire measurement.
- ³ With auto offset correction.
- ⁴ ±(% of reading + % of full scale).
- ⁵ For AC modes with DC coupling.

Pin Assignment

U-Measurement

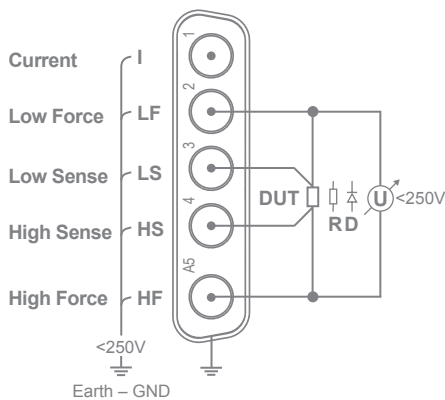

I-Measurement

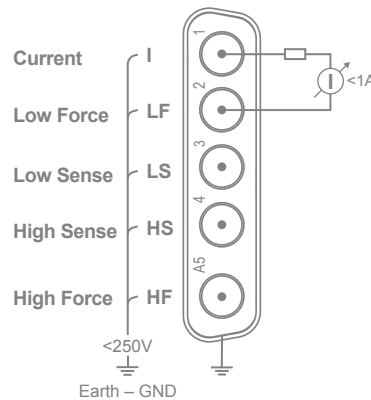

Trigger Lines

